

Article number: 201463B30402SW

Description: E+G
Flanged Connector GN 146.3-B30-40-2-SW

Measures

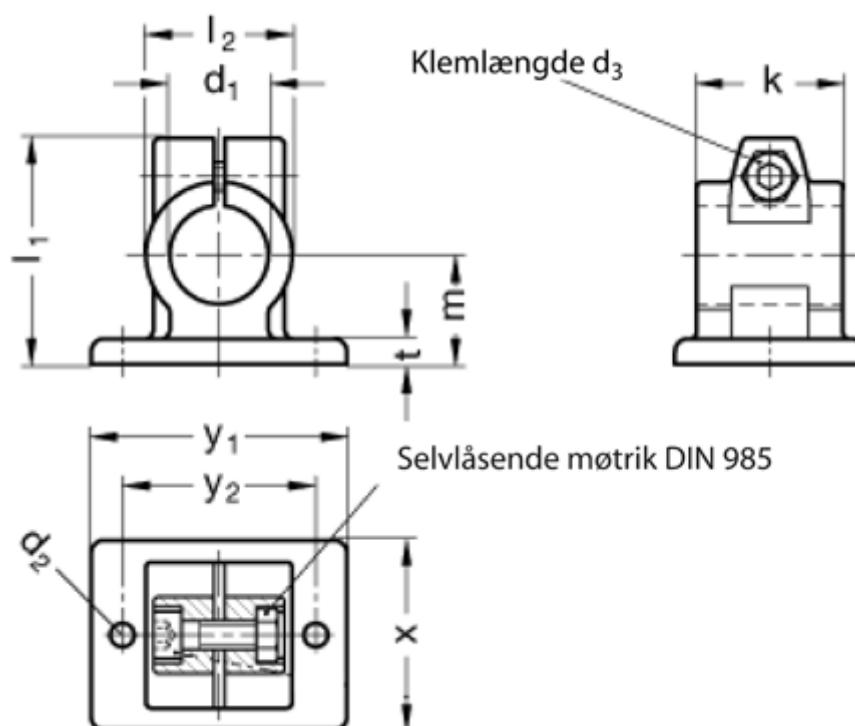

Adjustable clamp lever = GN 911-M 8-32 have to be ordred separately

d_1 = B30
 d_2 = 6.5
 d_3 = M 8
 k = 40
 l_1 = 62
 l_2 = 40
 m = 30

t = 7
 x = 52
 y_1 = 70
 y_2 = 53